

Alphabet Coloring Pages (A-Z)

Learn & Color letter -A,a

Name

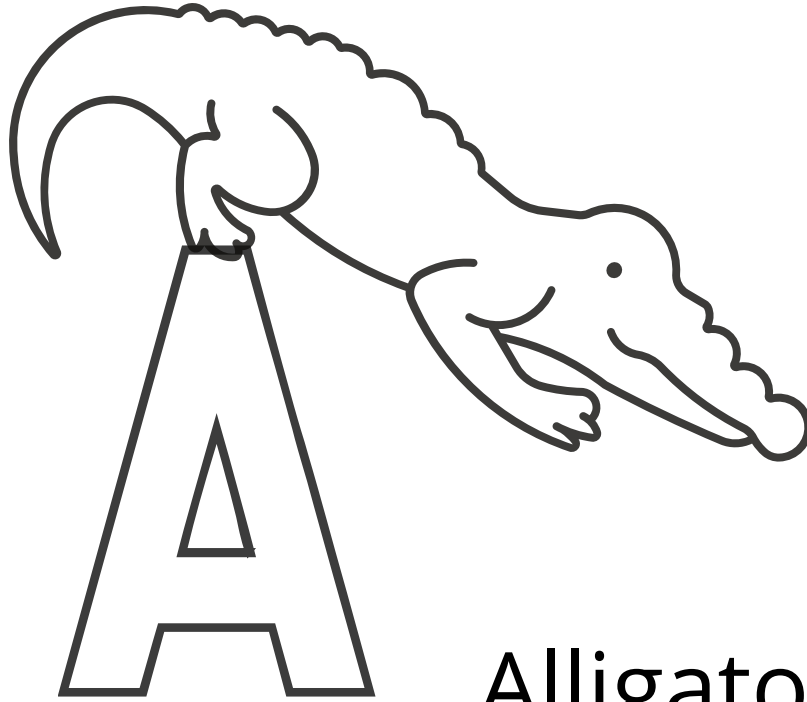

Alligator



apple

Learn & Color letter -**B,b**

Name

B

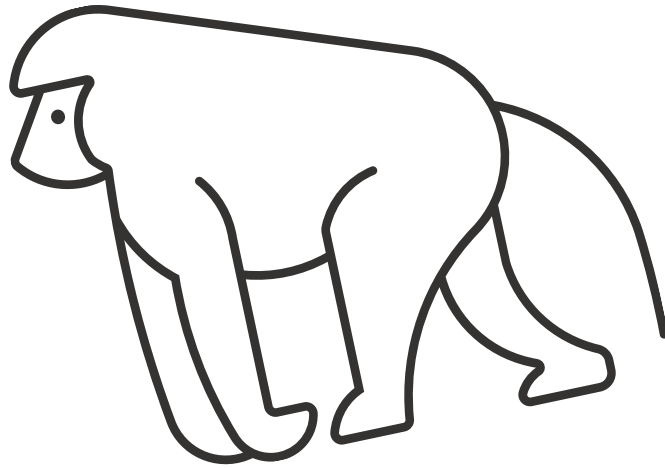

Baboon

b

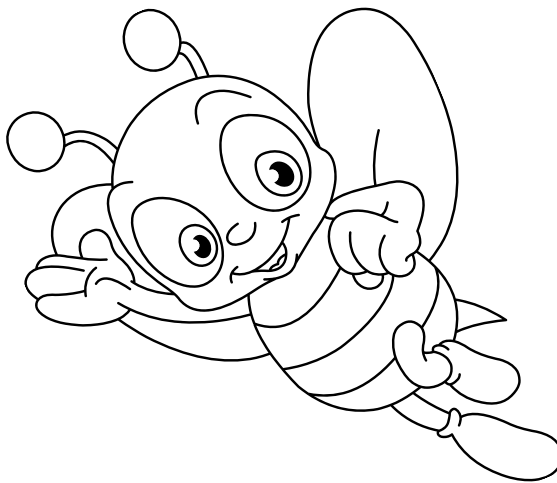

bee

Learn & Color letter -C,c

Name

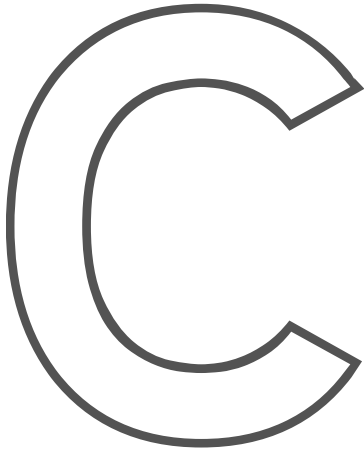

Cupcake

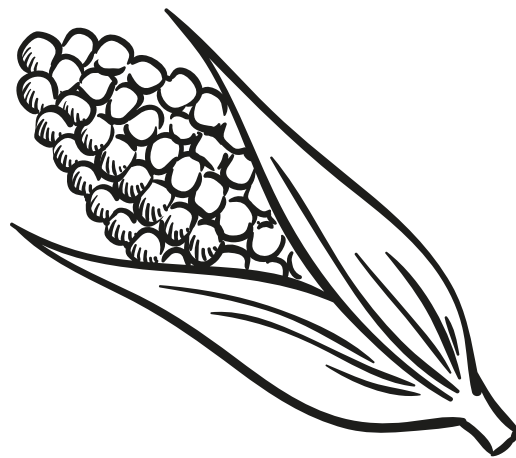

corn

Learn & Color letter -**D,d**

Name

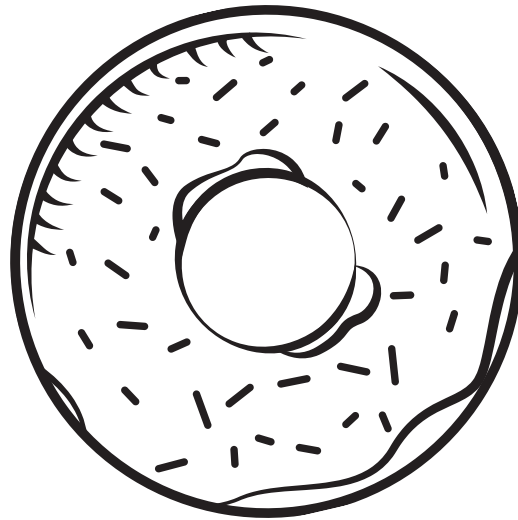

Donut

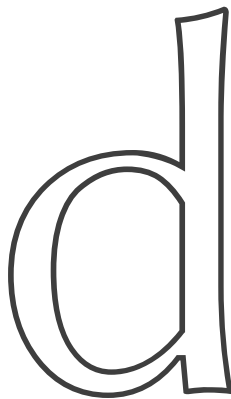

dad

Learn & Color letter -E,e

Name

E



Elephant



e

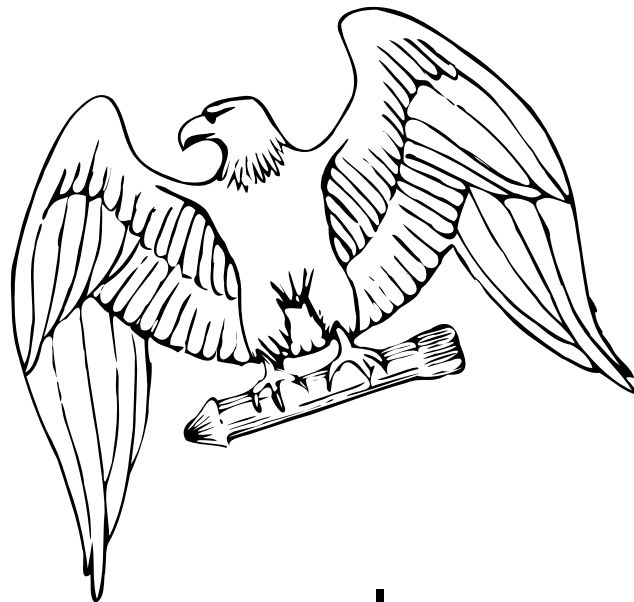

eagle

Learn & Color letter -F,f

Name

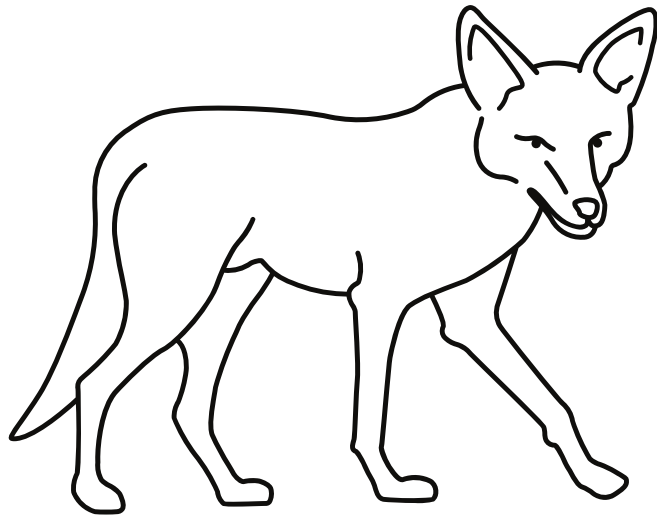
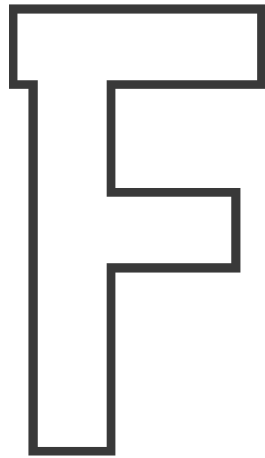

Fox

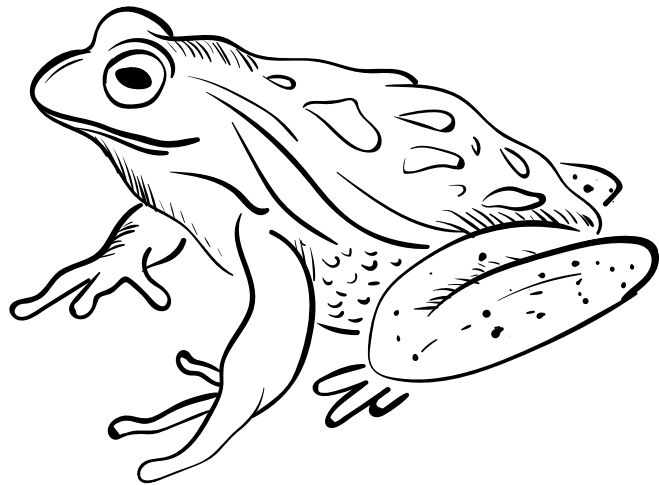
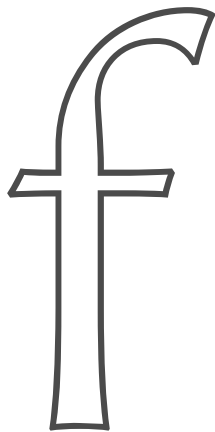

Frog

Learn & Color letter -G,g

Name

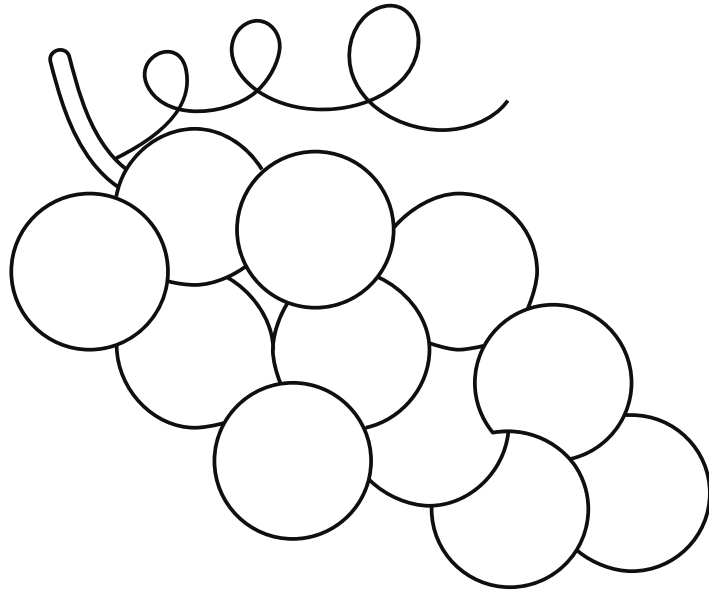

Grapes

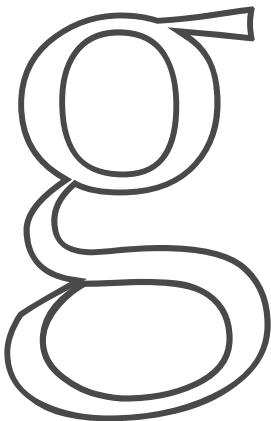

guitar

Learn & Color letter -H,h

Name

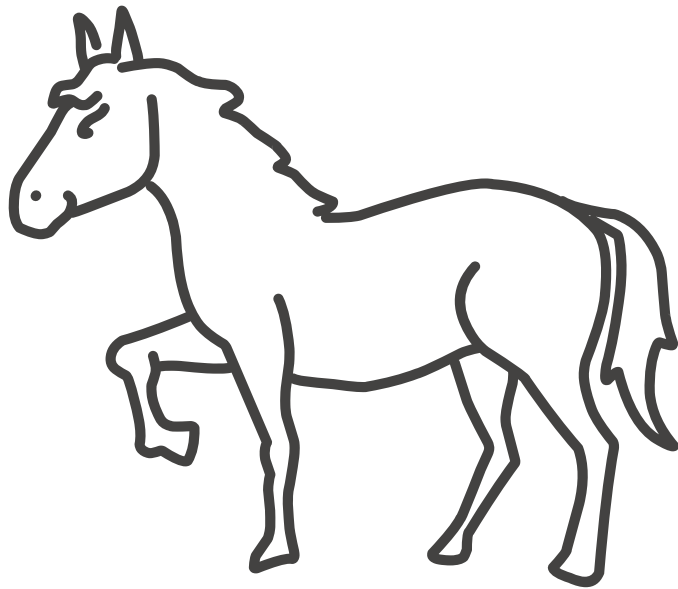
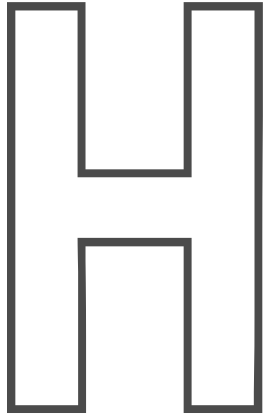

Horse

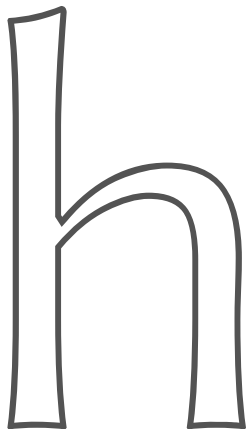

hamster

Learn & Color letter -I,i

Name

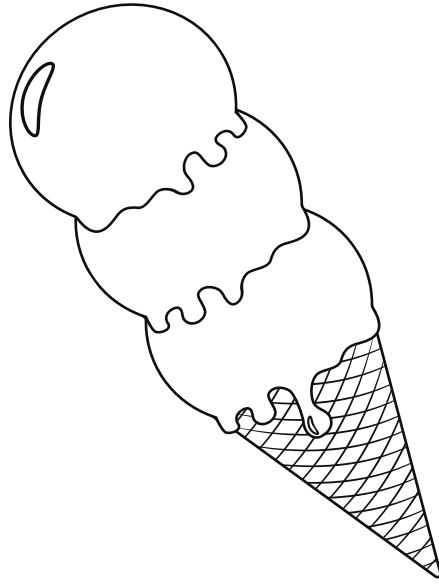

Ice cream

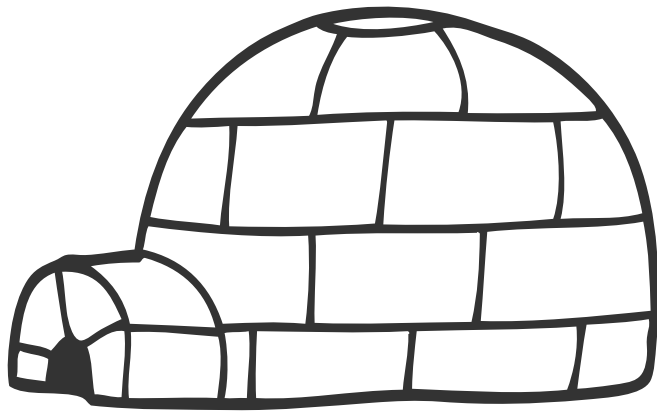

igloo

Learn & Color letter -J,j

Name

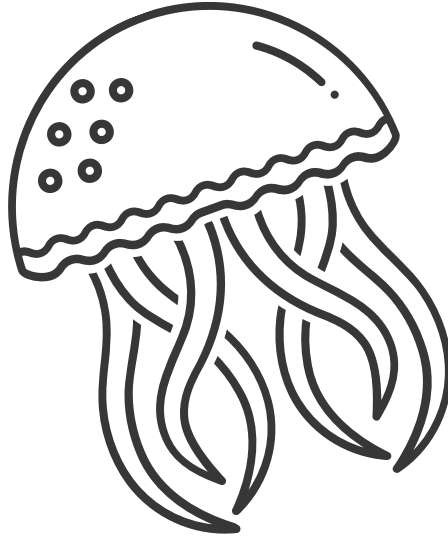

Jelly fish

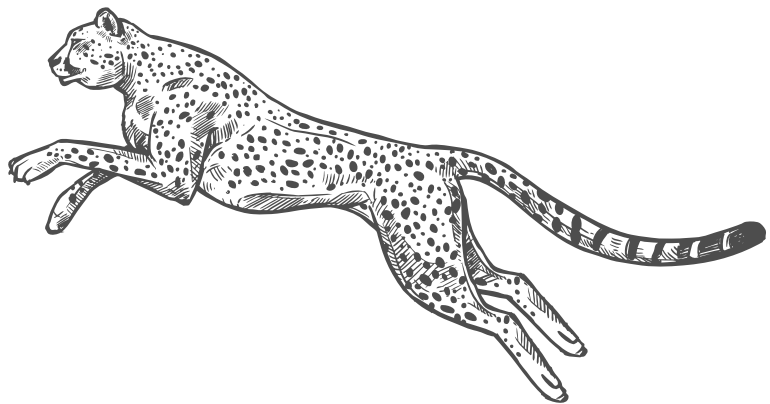
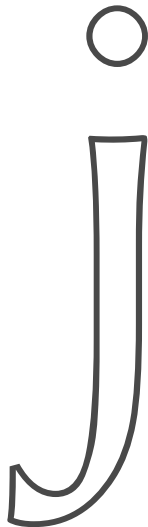

jaguar

Learn & Color letter -**K,k**,

Name

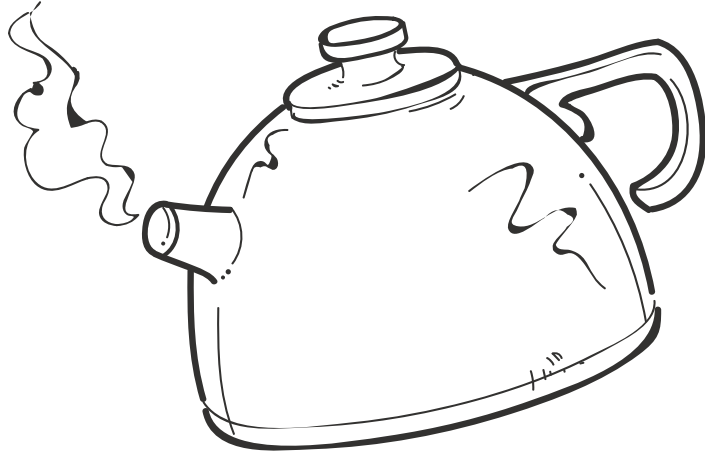
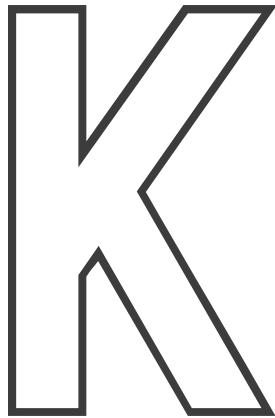

Kettle

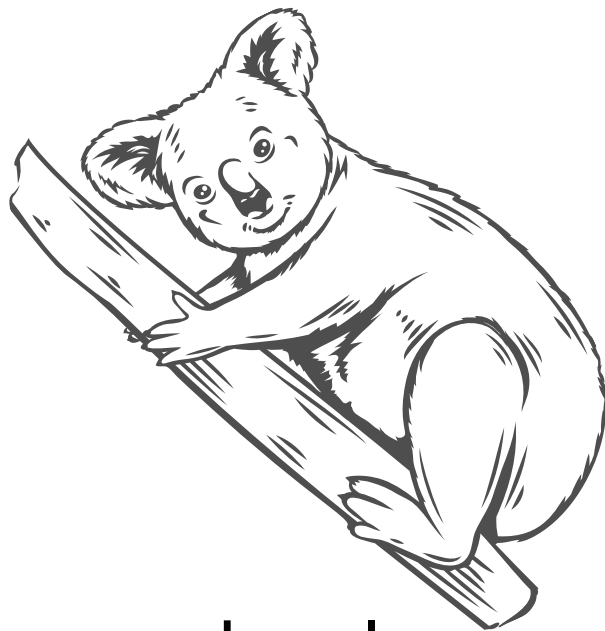
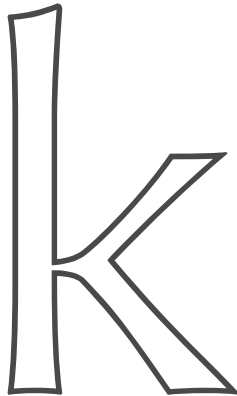

koala

Learn & Color letter -L, I

Name

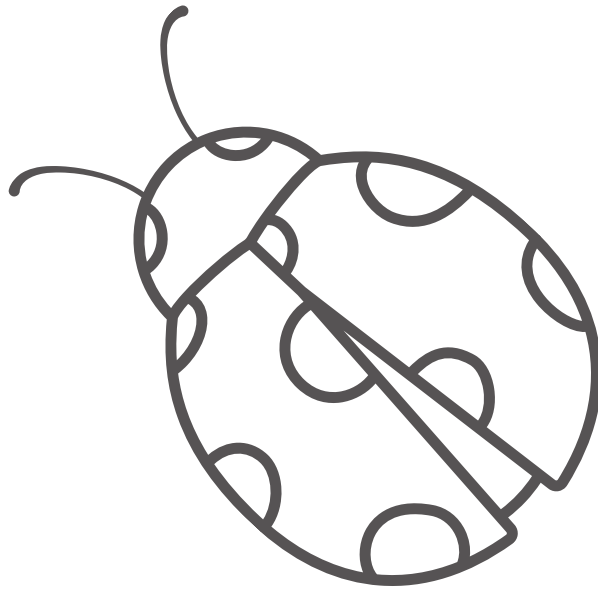
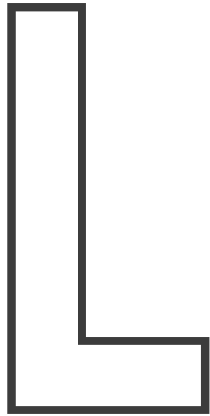

Ladybug

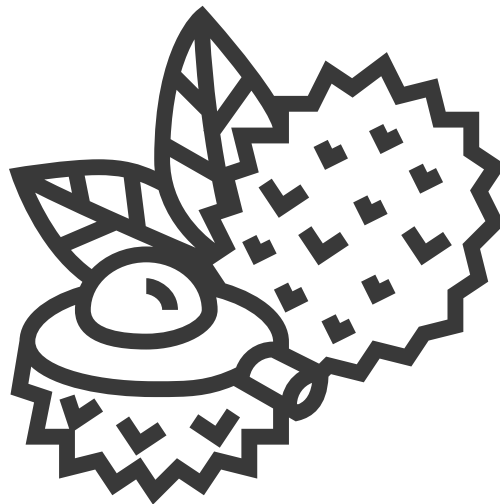

lichies

Learn & Color letter -M, m

Name

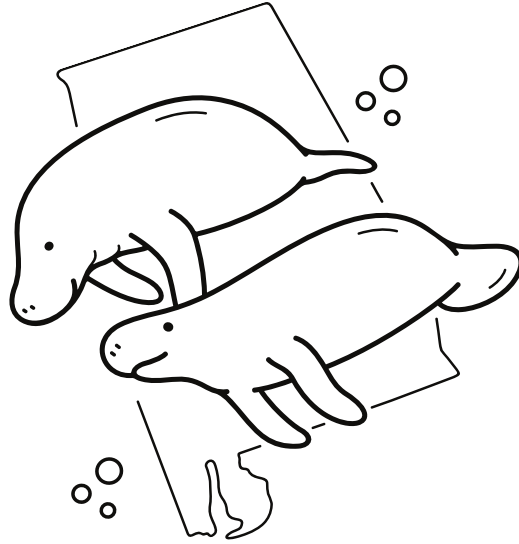

Manatee

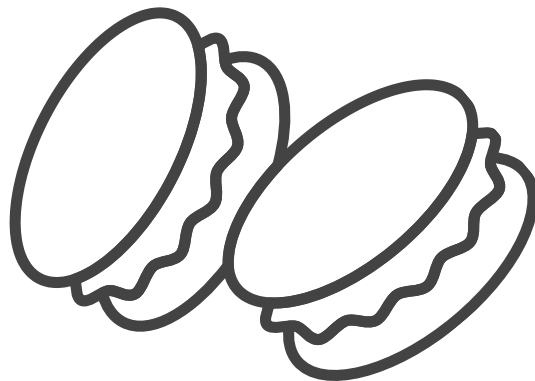
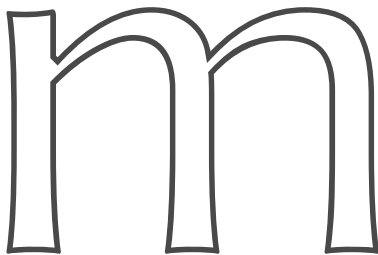

macarons

Learn & Color letter -N, n

Name



Nest

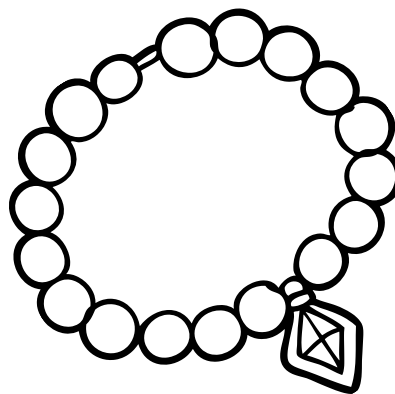
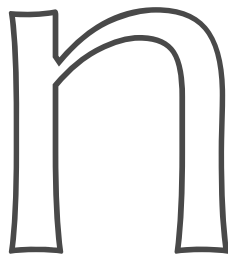

necklace

Learn & Color letter - O o

Name

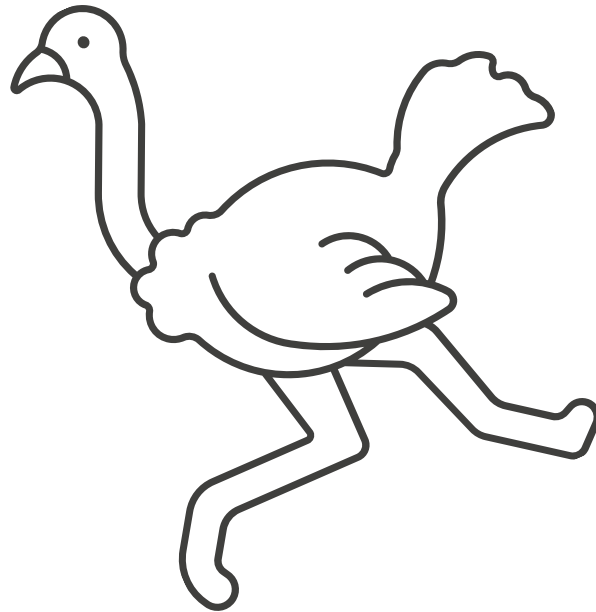
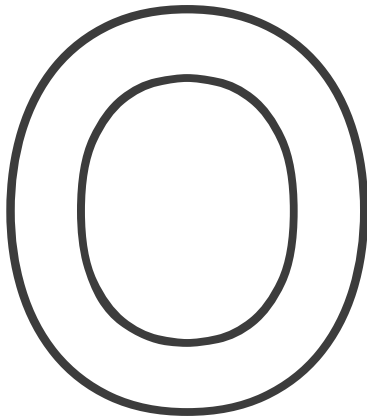

Ostrich

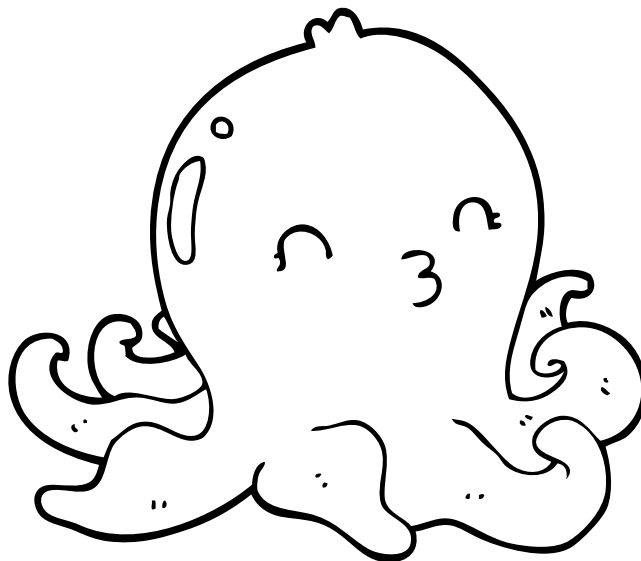
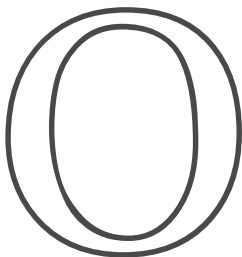

octopus

Learn & Color letter -P,p

Name

P



Penguin

p

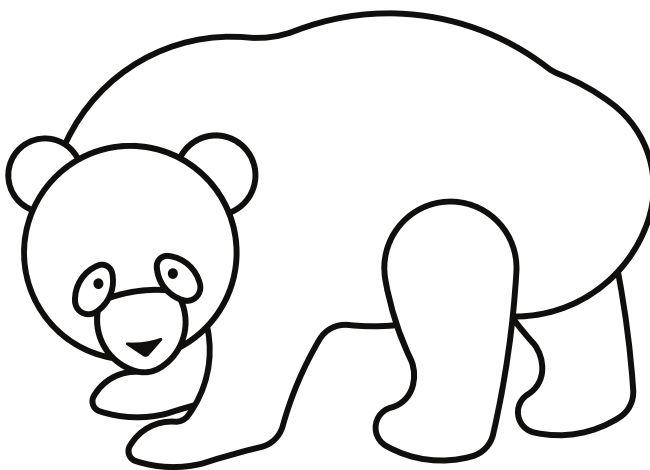

panda

Learn & Color letter -Q,q

Name

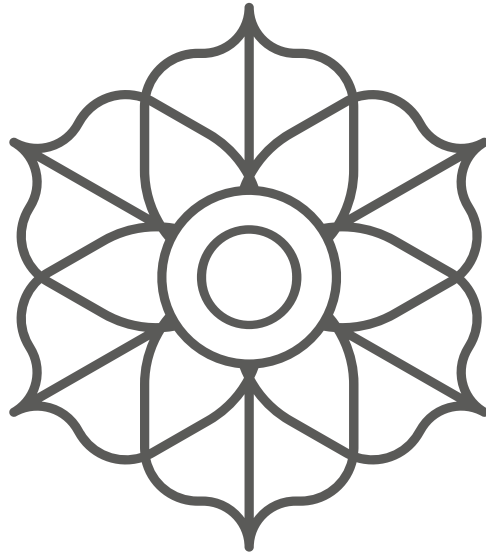
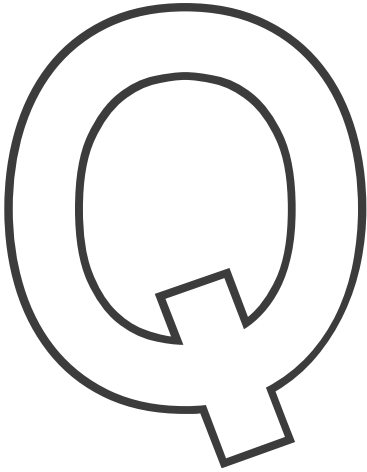

Quilt

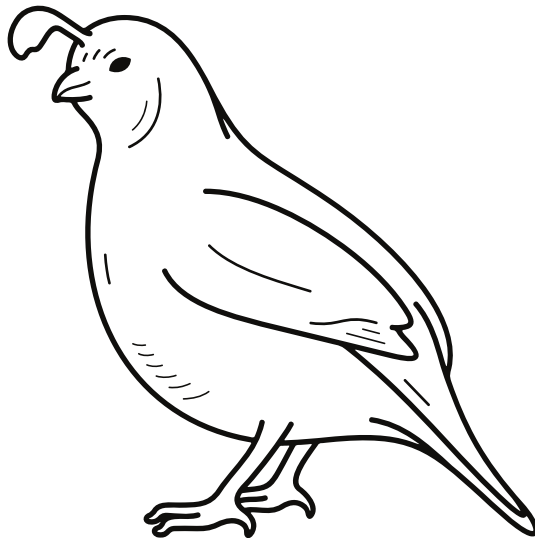
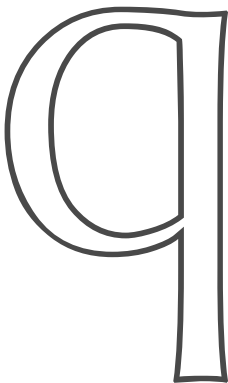

quail

Learn & Color letter -R,r

Name

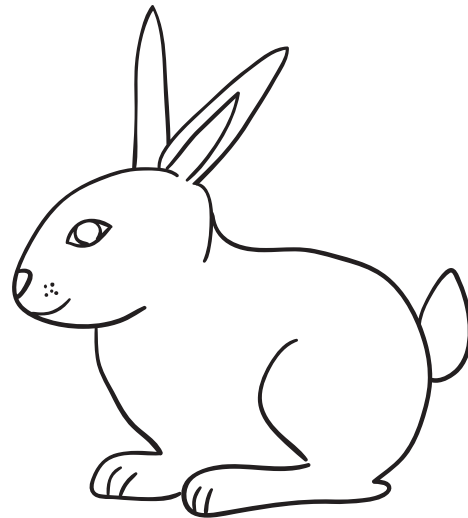

Rabbit

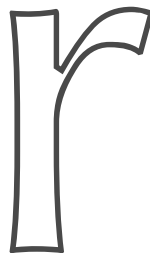

rain

Learn & Color letter -S,s

Name

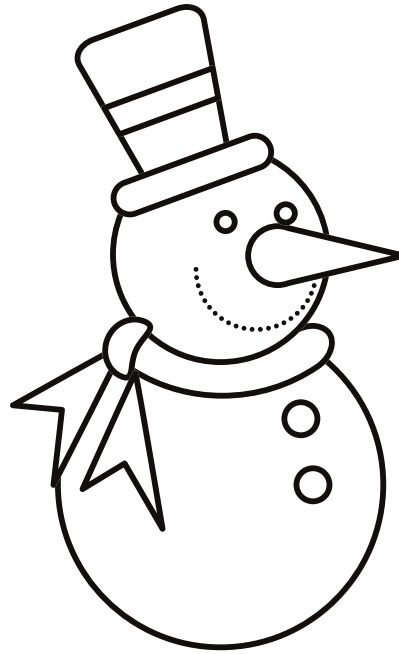
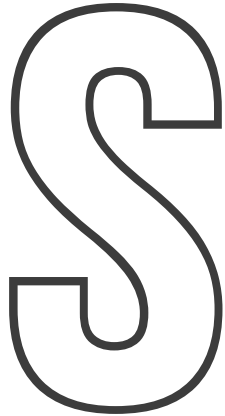

Snowman



santa

Learn & Color letter -T,t

Name

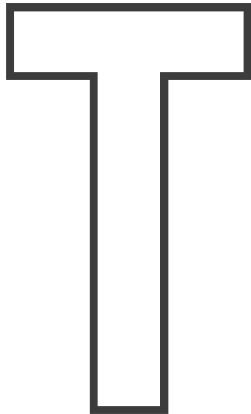

Teapot

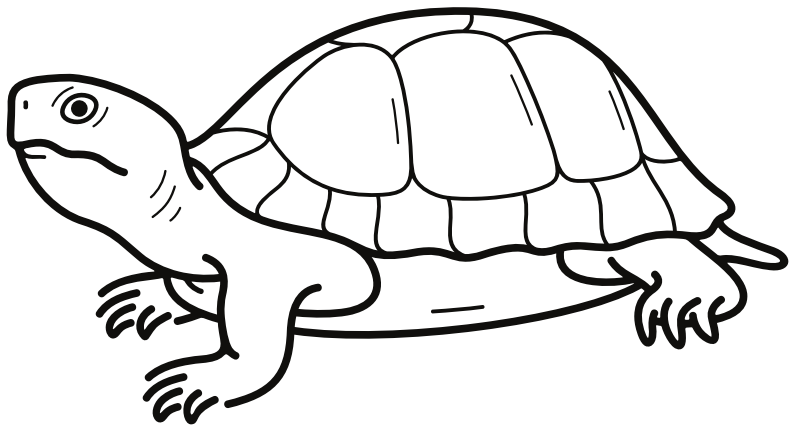
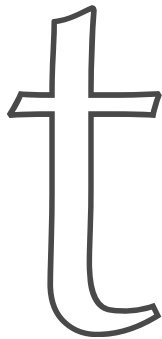

turtle

Learn & Color letter -U,u

Name

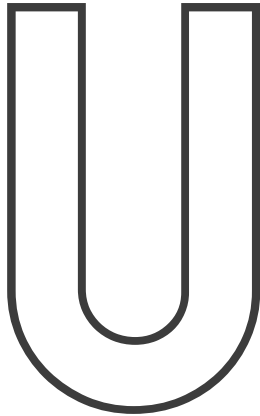

Umbrella

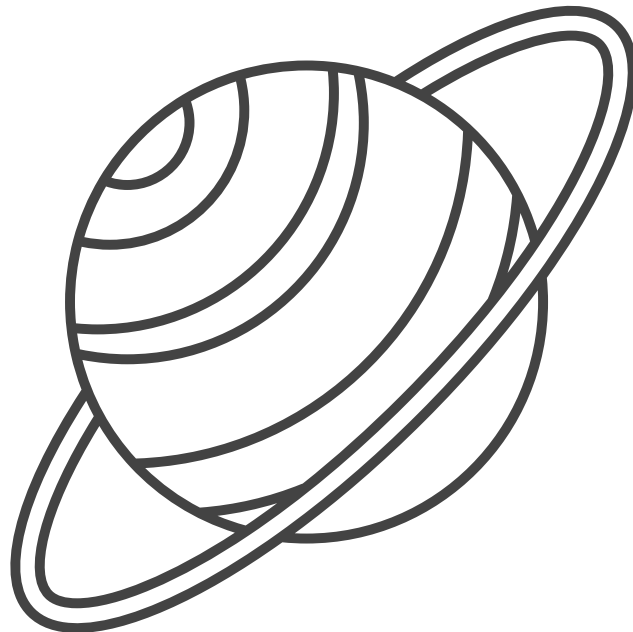
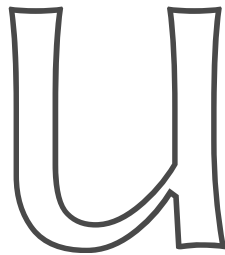

uranus

Learn & Color letter -V,v

Name



Vegetables

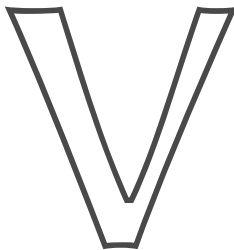

volcano

Learn & Color letter -**W,w**

Name

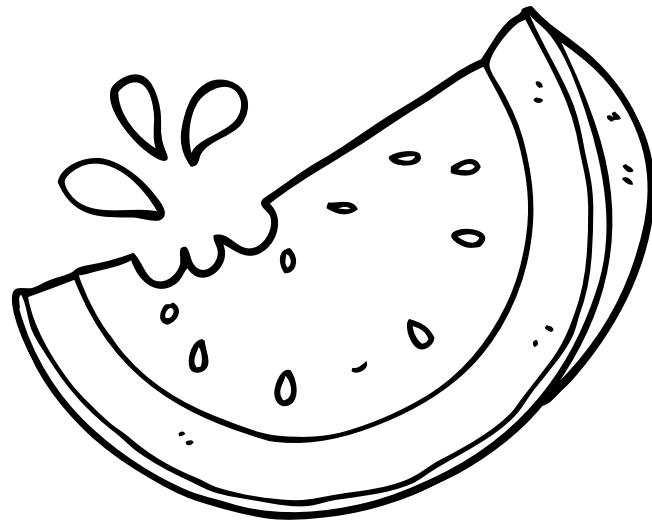

Watermelon

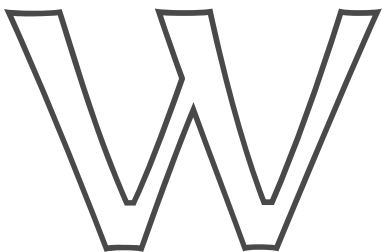

walnut

Learn & Color letter -X,x

Name

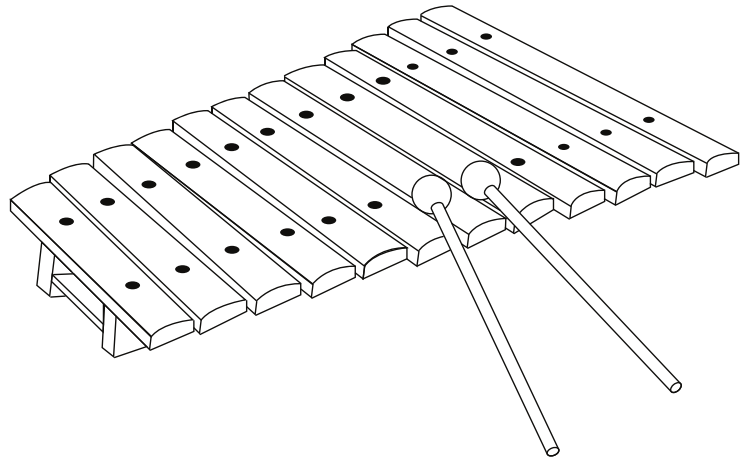

Xylophone

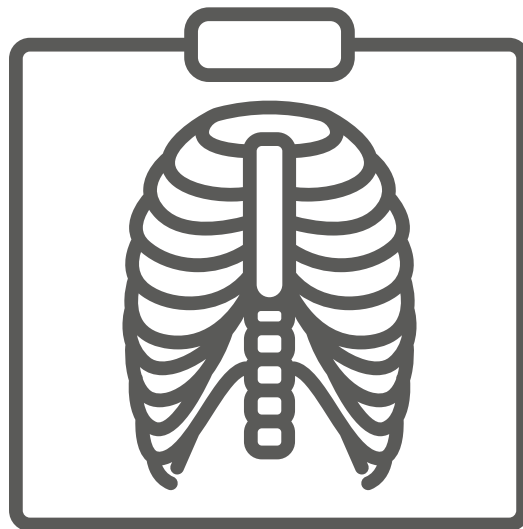

x-ray

Learn & Color letter -Y,y

Name

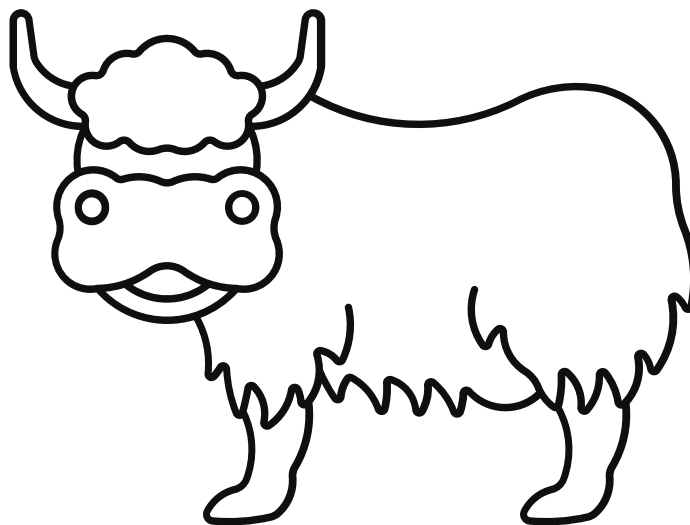
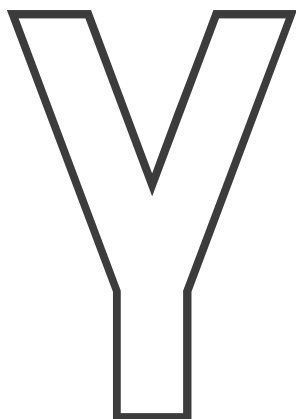

Yak

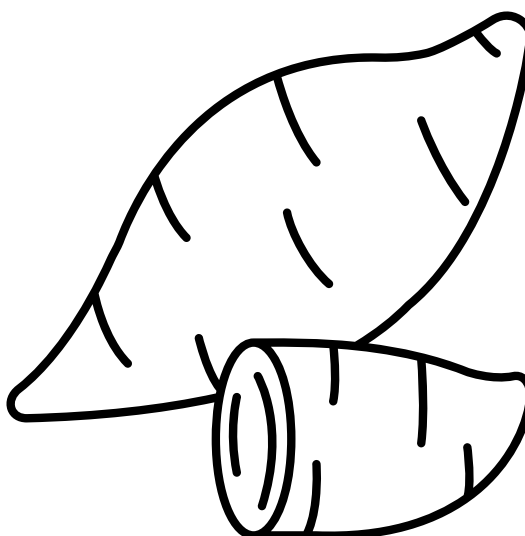
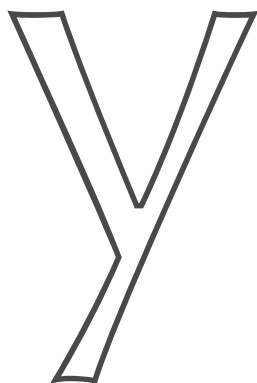

yam

Learn & Color letter -Z,z

Name

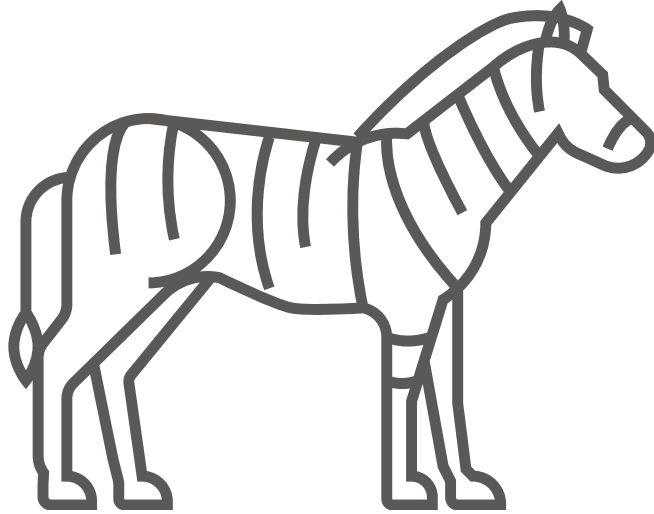

Zebra

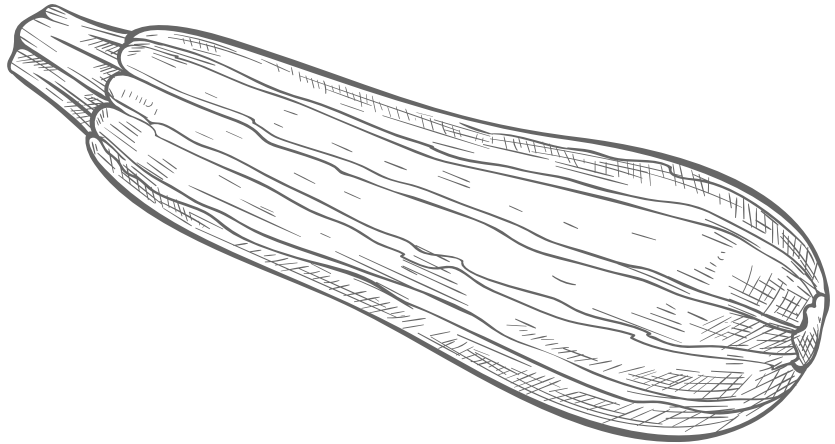

zucchini